



三 壑 力 達

Leader Samco



Leader Samco A7S/A8S

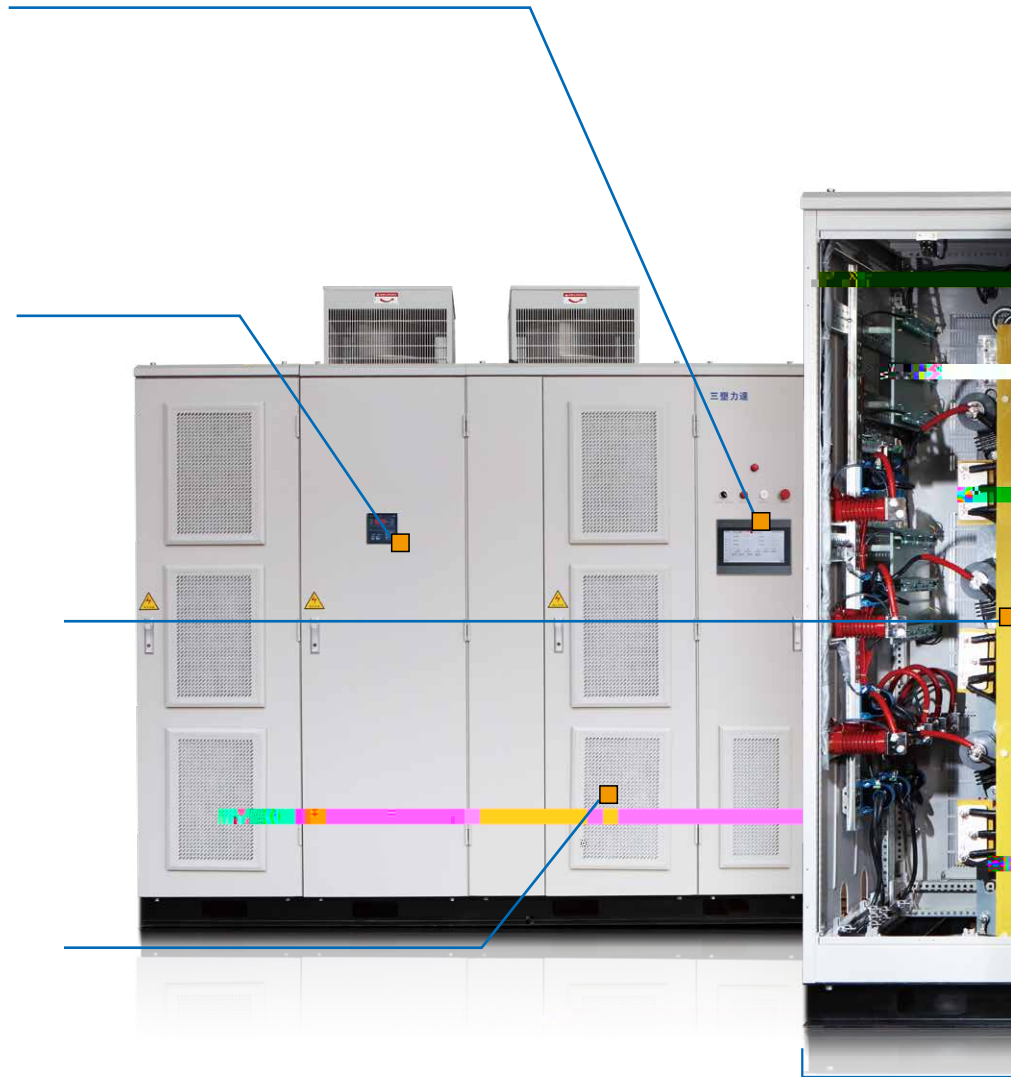

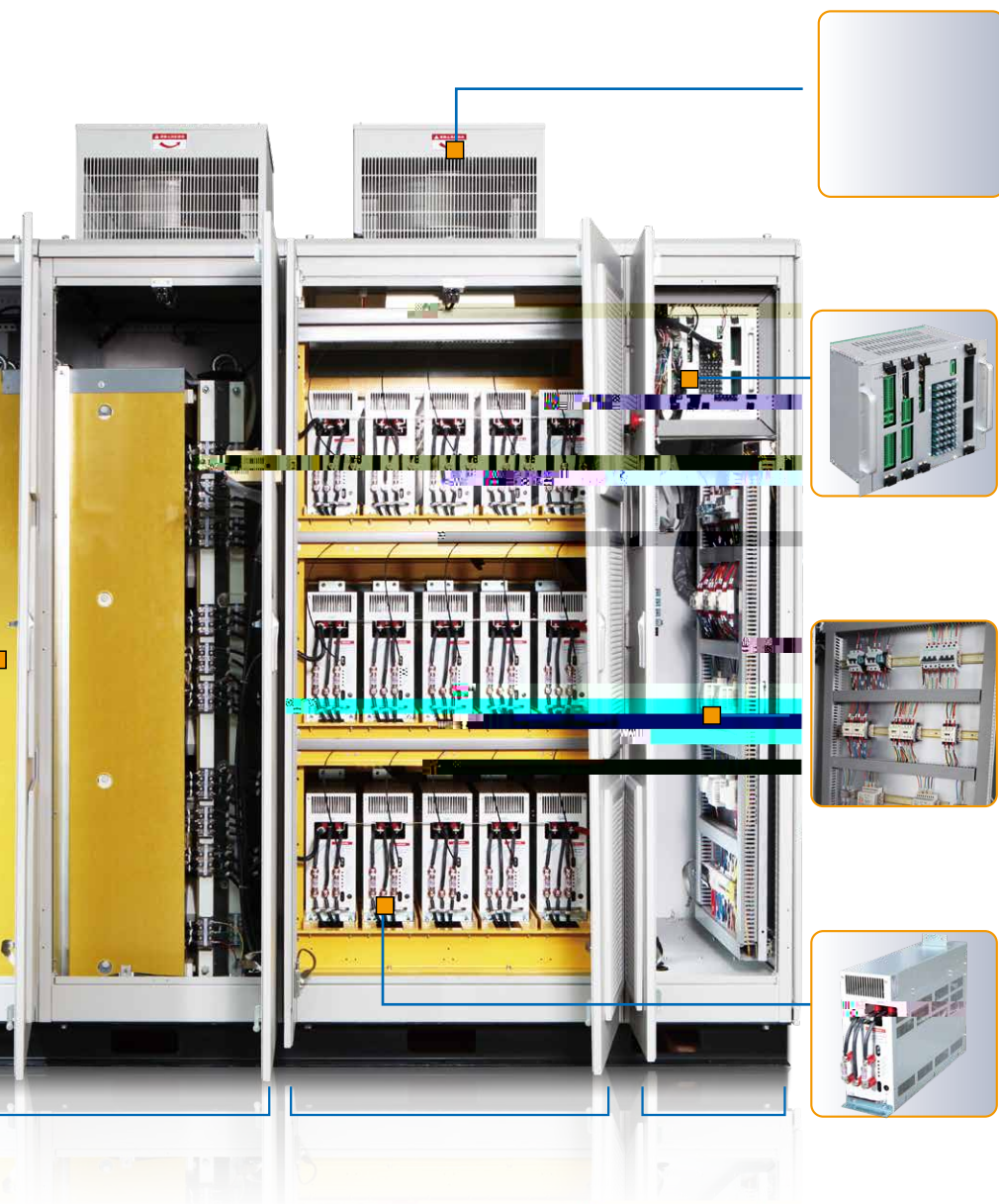

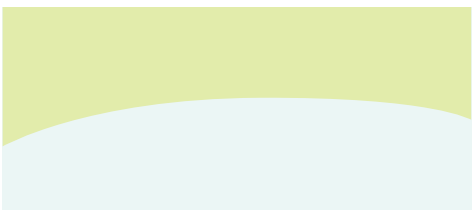
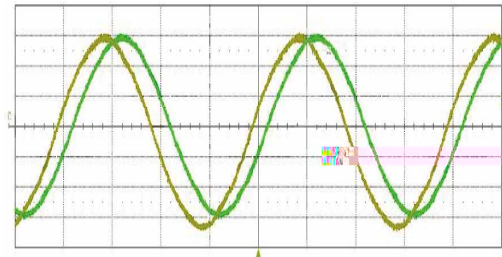
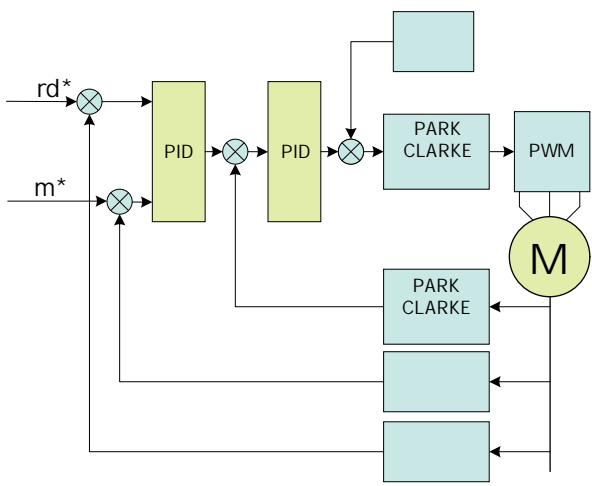

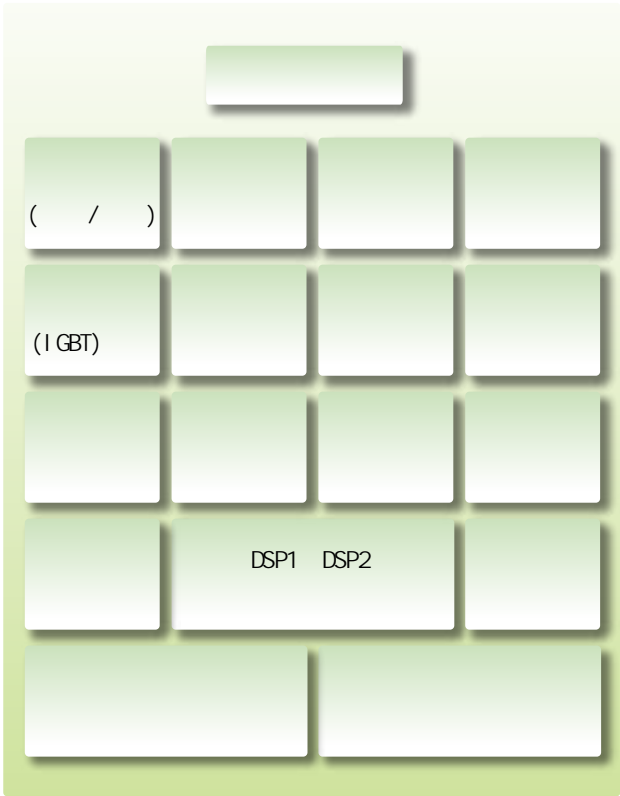
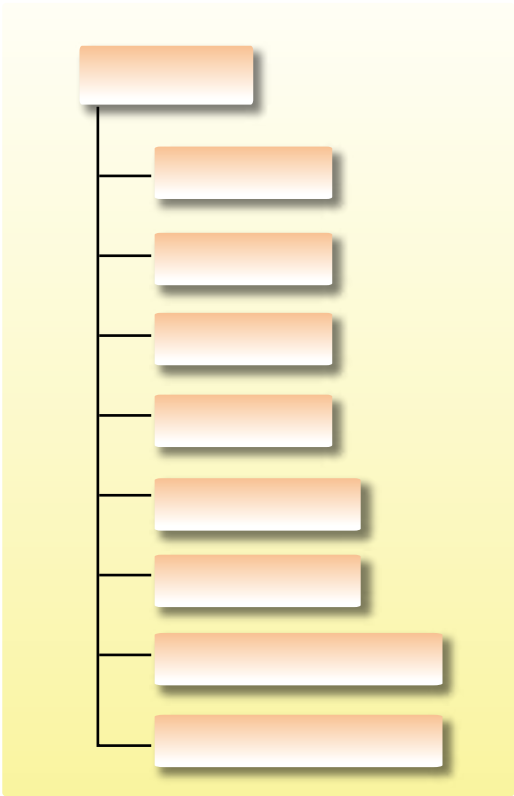

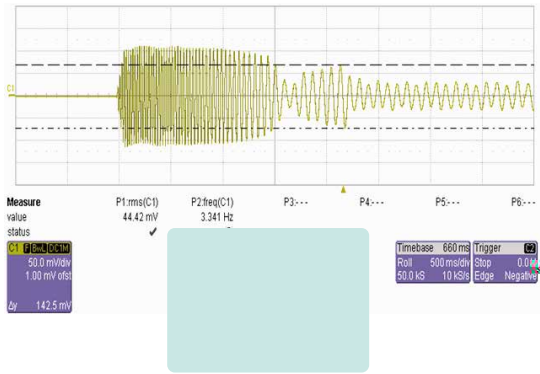
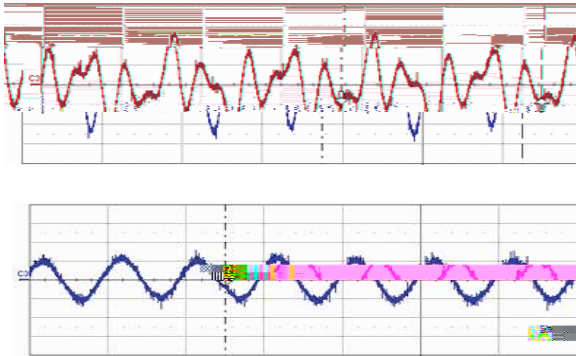

-
-

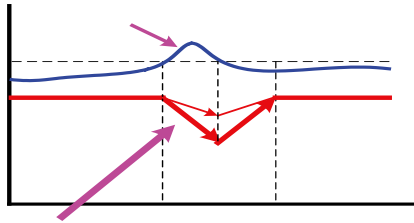

-
-

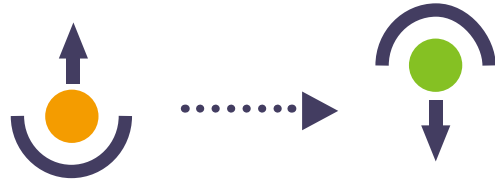

-
-

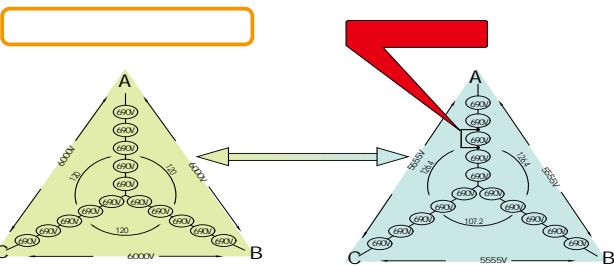

-
-



V/f

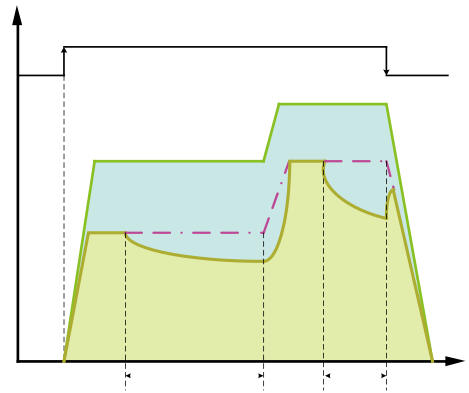
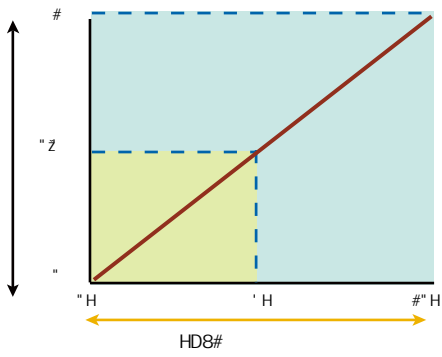

V/f

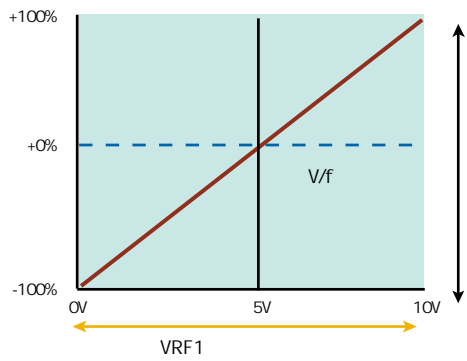

-
-
-
-
-
-
-

V/f





5



g

\





-
-
-
-
-
-
-
-
-

-
-
-
-

PID

-



Leader Samco A7S/A8S

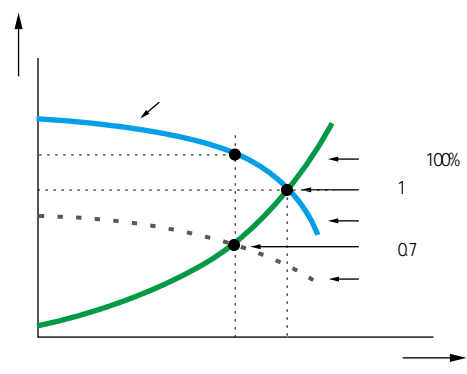
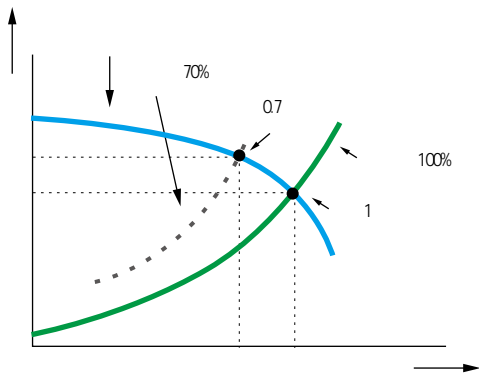

Leader Samco-A7S 3kV

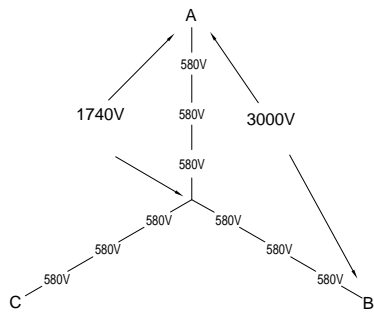

A7S 3kV

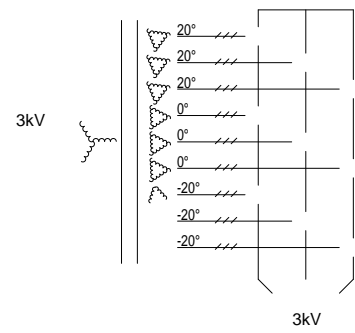

A7S 3kV

Leader Samco-A7S 3.3kV

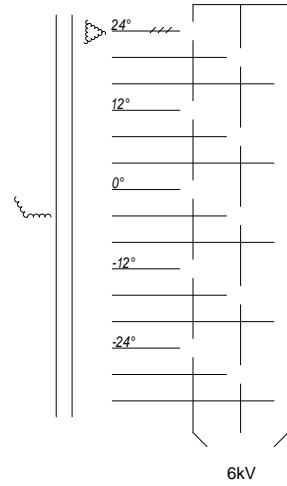
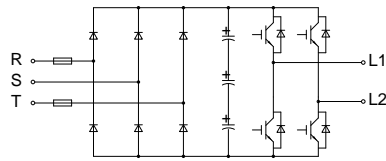
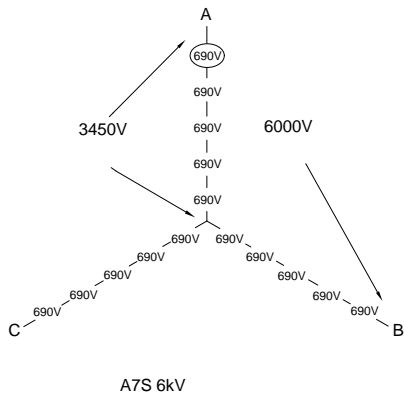

A7S 6kV

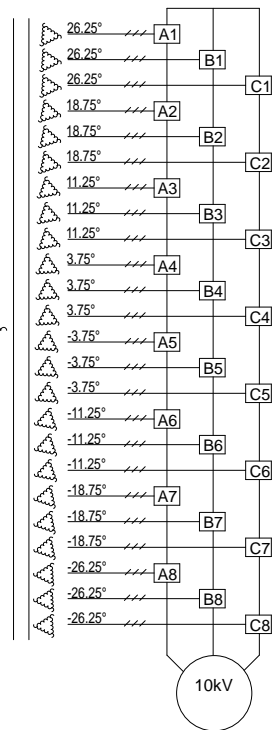
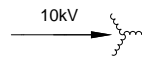
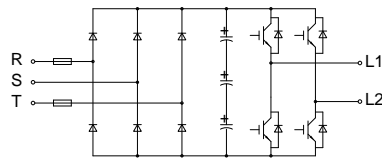
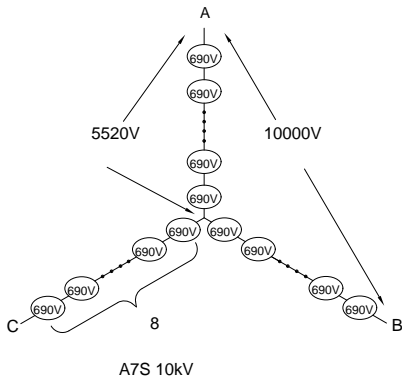

A7S 10kV

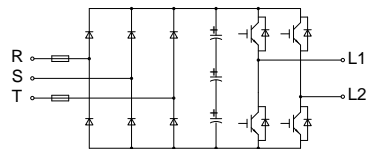

A8S 6kV

6kV

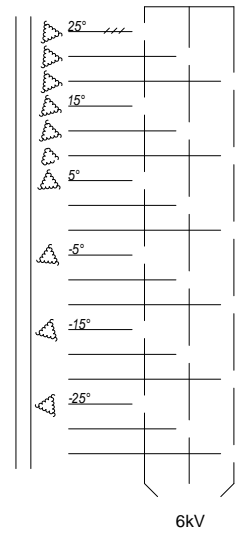

6kV

A8S 6kV

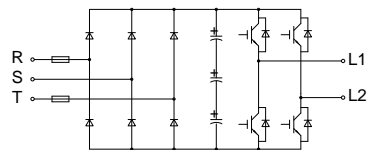
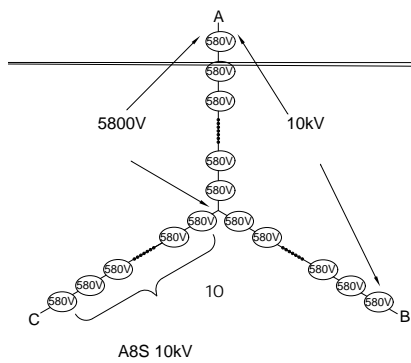

A8S 10kV

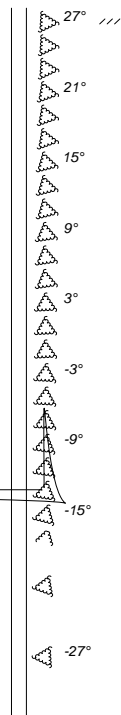

		$\leq 1000V/\mu$

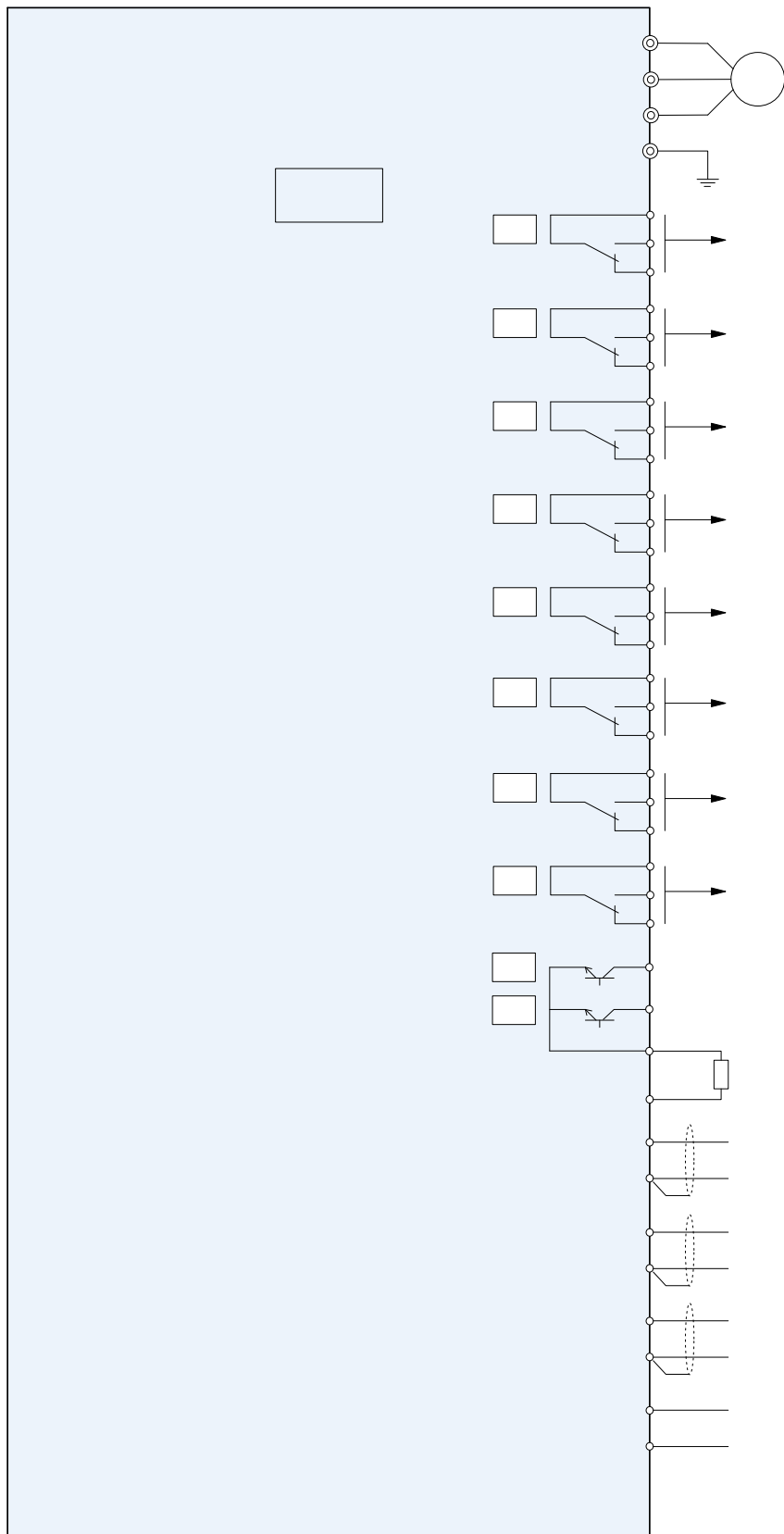

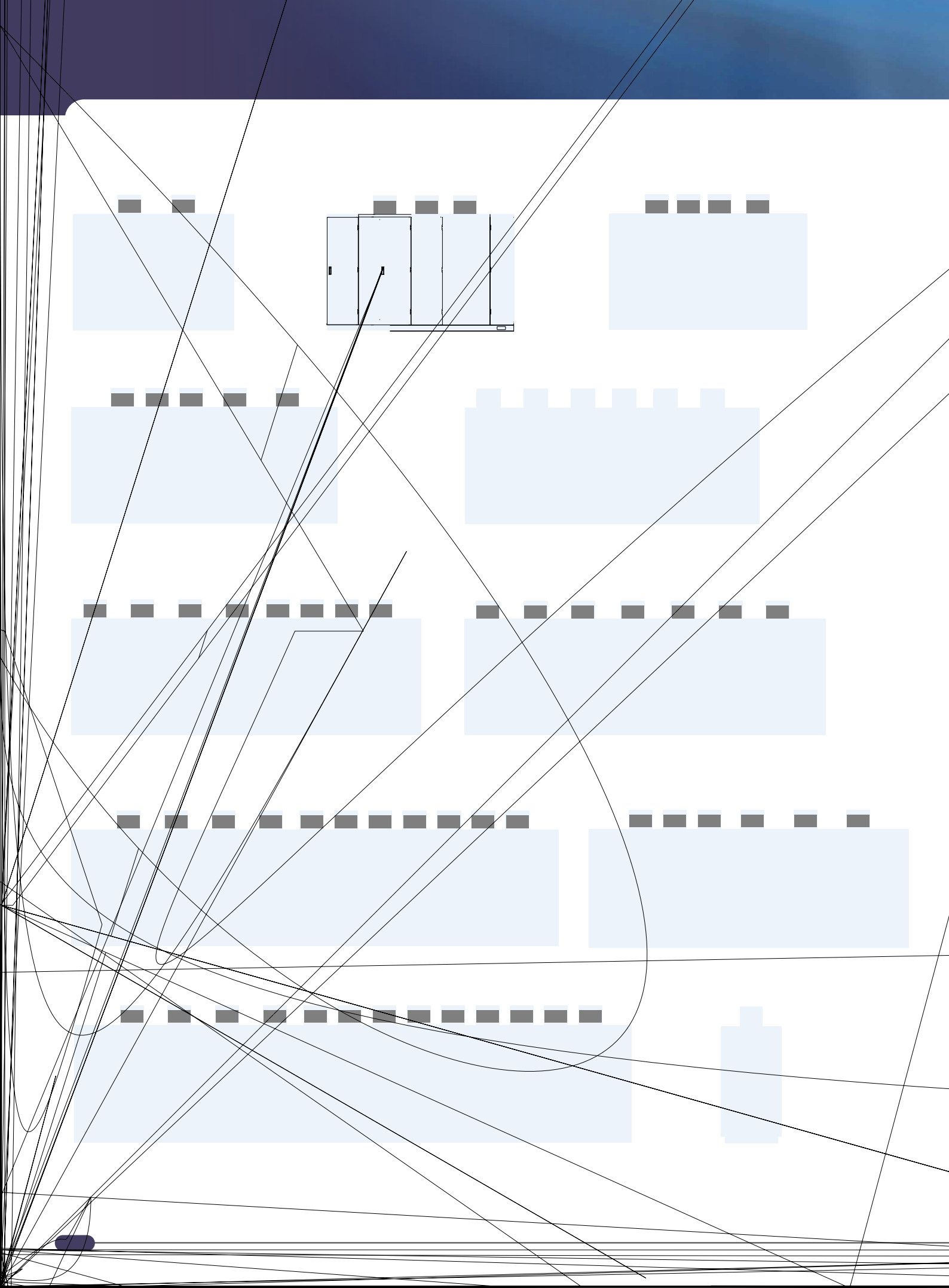

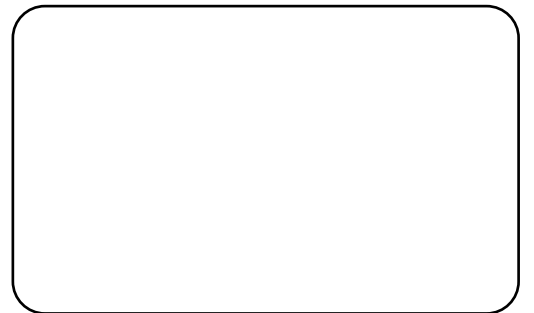

()

